

BY MERCANTLIS<sup>®</sup>

# FIX**bond**

ALUMINIUM COMPOSITE PANEL

Carta de cores  
Color chart  
Carte de couleurs

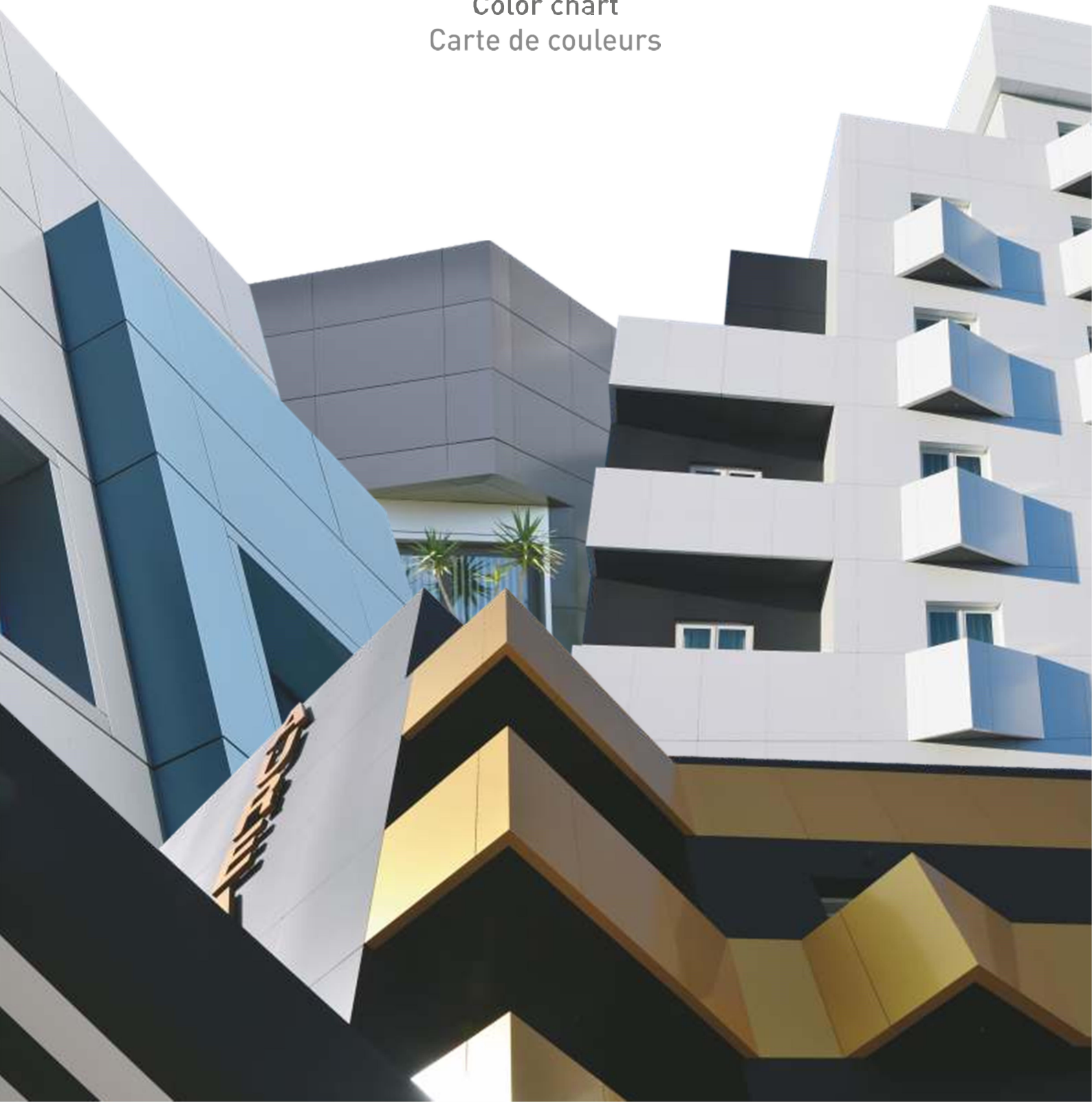

O painel **FIXBOND®FR** foi desenvolvido para satisfazer as mais elevadas exigências da legislação em vigor contra o fogo. O seu núcleo interno de resinas termoplásticas (polietileno de baixa densidade e retardadores de chama) tem a classificação ao fogo B-S1,d0 de acordo com a norma UNE-EN-13501-1:2007.

The **FIXBOND®FR** panel has been developed to comply with the highest demands from current norms for fire protection. Its internal core consisting of thermoplastic resins (low density polyethylene and fire retardant) has a fire classification of B-S1,d0 according to UNE-EN-13501-1:2007.

Le panneau **FIXBOND®FR** a été développé pour répondre aux plus grandes exigences de la réglementation en vigueur contre le feu. Son noyau intérieur en résines thermoplastiques (polyéthylène à faible densité et retardateur au feu) possède la classification au feu B-S1,d0 conforme à la norme UNE-EN-13501-1:2007.



**FIXBOND®A2** é um painel composto não combustível composto por duas folhas de alumínio e um núcleo mineral. O seu núcleo mineral possui a classificação de ao fogo reacção ao fogo A2-s1, d0 de acordo com a norma UNE-EN-13501-1:2007.

**FIXBOND®A2** is a non-combustible composite panel composed of two aluminium sheets and a mineral core. Its mineral core has fire classification A2-s1, d0 according to the UNE-EN-13501-1:2007 standard. It has excellent mechanical properties, among which are: excellent rigidity, excellent flatness, impact resistance, durability and ease of maintenance.

**FIXBOND®A2** est un panneau composite incombustible composé de deux feuilles d'aluminium et d'un noyau minérale. Son noyau minéral est classé au feu A2-s1, d0 selon la norme UNE-EN-13501-1:2007.

Il possède d'excellentes propriétés mécaniques, parmi lesquelles se distinguent: une excellente rigidité, une excellente planéité, une résistance aux chocs, une durabilité et une facilité d'entretien.

- Protective filme
- Protective Varnish
- PVDF 70/30 Paint
- Primary
- 0.5mm aluminium (5005 alloy)
- Adhesive
- Mineral Core
- Adhesive
- 0.5mm aluminium (3105 alloy)
- Primary (Epoxy-based)

O painel **FIXBOND®** possui uma camada exterior de liga de alumínio 3005/ 3105/ 5005, sendo revestido com pintura da mais alta qualidade PvdF Kynar® 500 70/30 (fluoreto de vinilo), o que proporciona a maior resistência ao envelhecimento. O fabrico do painel compósito **FIXBOND®** segue um processo controlado por rigorosos testes e controlo de qualidade.

The **FIXBOND®** panel has an external aluminium alloy 3005/ 3105/ 5005 sheet and is coated with the highest quality PvdF Kynar® 500 70/30 paint (polyvinyl fluoride) that offers the highest resistance to ageing. The manufacture of **FIXBOND®** Composite Panel follows a controlled process by way of rigorous tests and quality controls.

Le panneau **FIXBOND®** avec une couche extérieure en alliage d'aluminium 3005/ 3105/ 5005 et laqué à la peinture PvdF Kynar® 500 70/30 (polyvinyle fluoré), offre une haute résistance au vieillissement. La fabrication du Panneau Composite **FIXBOND®** répond à un processus de contrôle rigoureux validé par des essais et des audits de qualité.



**A2 & FR cores**  
Núcleos A2 y FR  
Noyaux A2 et FR



**High resistance to UV rays**  
Alta resistencia a rayos UV  
Haute résistance aux rayons UV



**Excellent weight/surface value**  
Excelente relación peso/superficie  
Excellent rapport poids/surface



**Easily conformable**  
Fácilmente conformable  
Facilement conforme



**Rapid and simple assembly**  
Montaje rápido y sencillo  
Montage simple et rapide



**Totally recyclable**  
Totalmente reciclable  
Totalement recyclable

# Mecanizados | Processes | Usinages

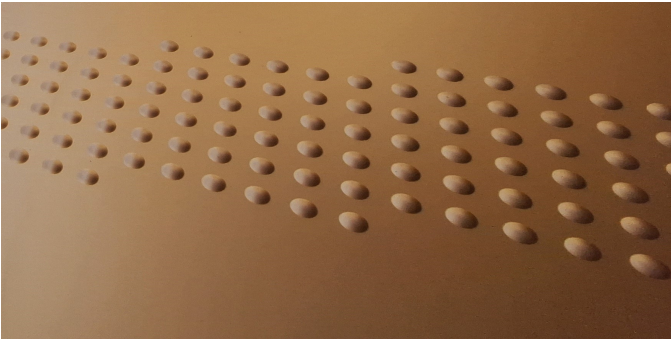

Fazemos todo o tipo de mecanizados que favoreçam a integração em qualquer arquitetura e facilitem os múltiplos requisitos estéticos.

We do all kind of machining, benefiting integration into any architecture and making adhering to multiple aesthetic requirements possible.

Nous faisons toutes sortes d'usinages favorisant l'intégration dans n'importe quel type d'architecture et facilitant les nombreuses obligations esthétiques.



## Cores Sólidas

## Solid Colors

## Couleurs Solides

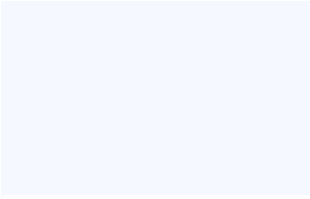

FB-401  
Arctic White



FB-413  
Traffic White

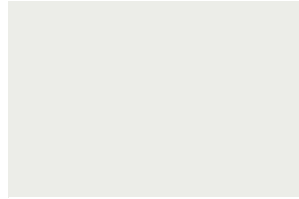

FB-459  
Signal White



FB-420  
Pure White



FB-439  
Light Grey

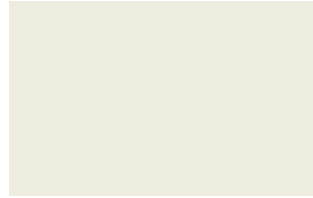

FB-492  
Grey White

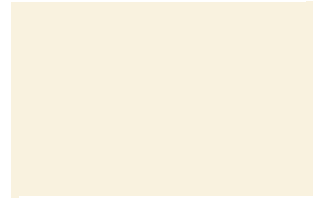

FB-455  
Cream

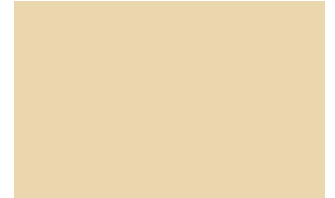

FB-485  
Ivory



FB-565  
Autumn Grey



FB-4A5  
Dusty Grey



FB-458  
Mouse Grey



FB-469  
Iron Grey

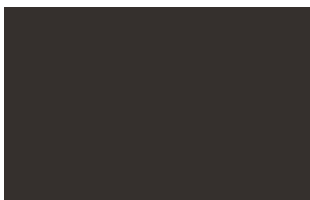

FB-417  
Umbra Grey



FB-4E3  
Graphite Grey



FB-4X5  
Charcoal



FB-478  
Anthracite Grey



FB-564  
Twilight Bronze



FB-451  
Black Grey



FB-415  
Black



FB-430  
Natural Blue



FB-412  
Ultramarine Blue

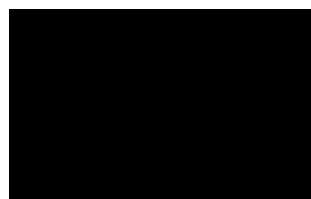

FB-473  
Steel Blue



FB-484  
Yellow Green



FB-487  
Dark Green



FB-493  
Traffic Yellow



FB-495  
Orange



FB-411  
Traffic Red



FB-498  
Blood Red



FB-488  
Deep Red



FB-4C6  
Grey Brown



FB-494  
Brown

### Acabamentos Ultramatt

### Ultramatt Finishes

### Finitions Ultramatt

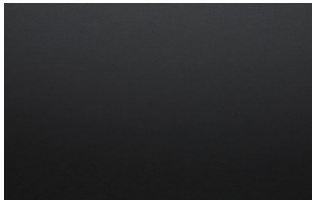

FB-425  
Ultramatt Black



FB-U03  
Bottle Green Matt

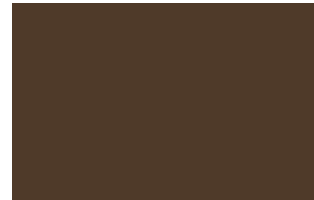

FB-U02  
Brown Matt

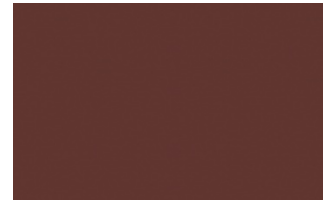

FB-U04  
Duron Maroon Matt

### Acabamentos Anodizados

### Anodized look Finishes

### Finitions Anodisées

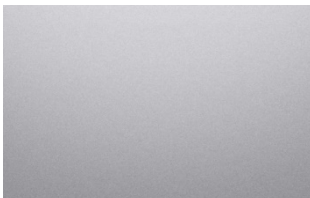

FB-588  
Anodic Clear



FB-E02  
Anodic Light



FB-E03  
Anodic Dark

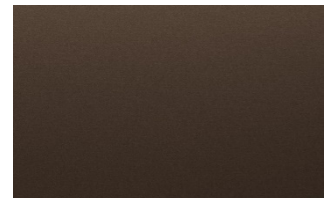

FB-4B3  
Anodic Shade

### Cores Metálicas

### Metallic Colors

### Couleurs Métallisées



FB-400  
White Metallic

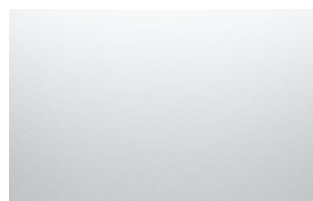

FB-405  
Champagne Metallic

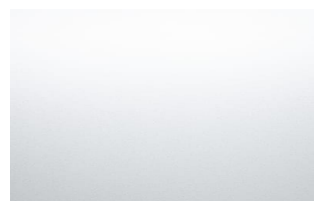

FB-403  
Silver Metallic

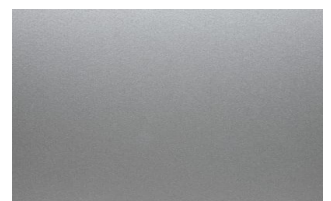

FB-402  
Grey Metallic

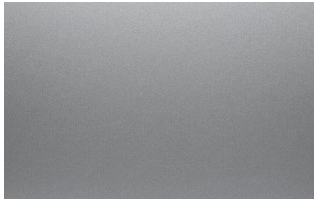

FB-407  
Titanium Metallic



FB-406  
Bronze Metallic



FB-454  
Gold Metallic



FB-409  
Blue Metallic



FB-410  
Jade Green



FB-414  
Copper Metallic

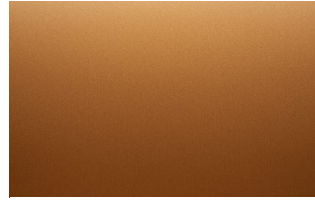

FB-4D7  
Intense Copper



FB-450  
Terracotta

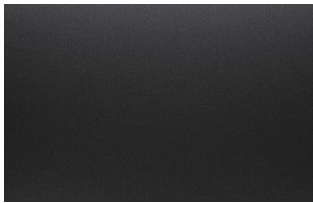

FB-408  
Carbon



FB-483  
Dark Grey

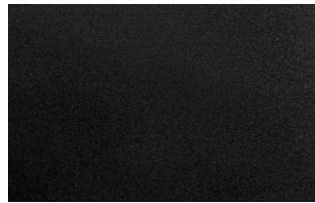

FB-589  
Black Stardust

### Acabamentos Madeira

### Wood Finishes

### Finitions Bois



FB-W45  
Straw Chestnut Sense



FB-W58  
Bark Chestnut Sense



FB-W46  
Linen Chestnut Sense



FB-W47  
Natural Chestnut Sense



FB-W48  
Autumn Chestnut Sense

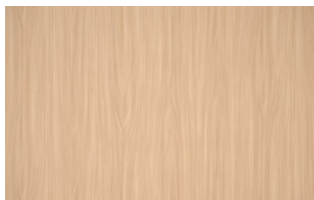

FB-W49  
Natural Oak Sense



FB-W50  
Mountain Oak Sense



FB-W52  
Mocha Oak Sense

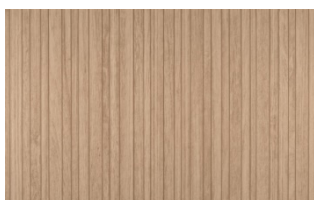

FB-W61  
Wood Strip Sense

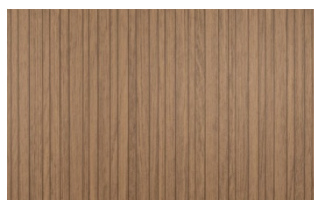

FB-W60  
Wood Town Sense

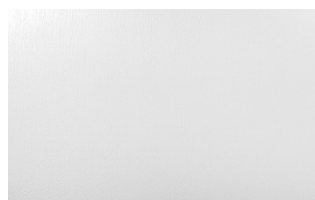

FB-U41  
White Wood Sense

## Acabamentos Especiais

## Special Finishes

## Finitions Spéciales



FB-M01  
Natural Mirror



FB-4C3  
Textured White

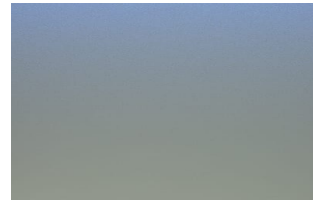

FB-S12  
Stellar Blue

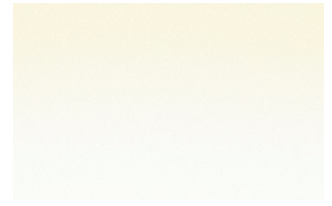

FB-S10  
Golden Pearl



FB-4D8  
Golden Sand

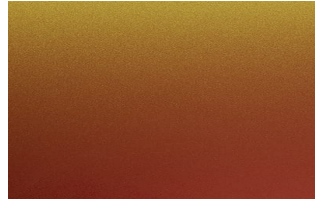

FB-S08  
Sunset

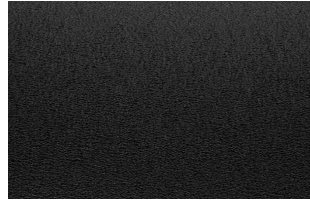

FB-4E9  
Rugged Black



FB-4F1  
High Gloss Black

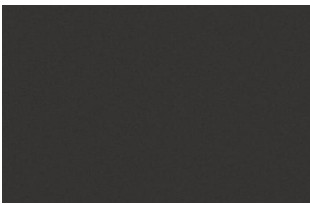

FB-4D5  
Grain Anthracite

## Acabamentos Urban

## Urban Finishes

## Finitions Urban

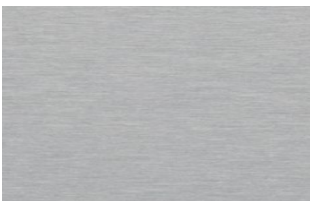

FB-449  
Natural Brushed



FB-B07  
Apollo Thin Brushed Metallic

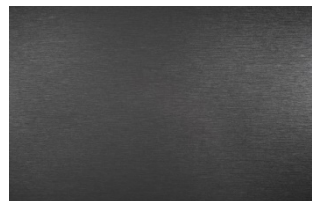

FB-B08  
Discovery Thin Brushed Metallic

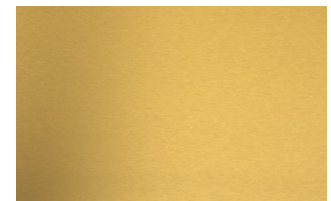

FB-582  
Gold Brushed

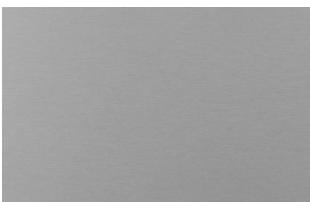

FB-B06  
Zinc Brushed

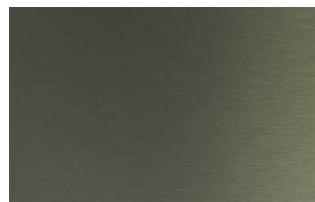

FB-584  
Olive Brushed

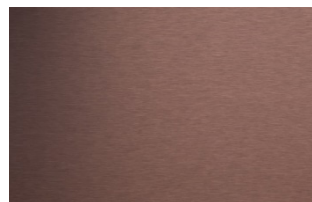

FB-583  
Antique Copper Brushed

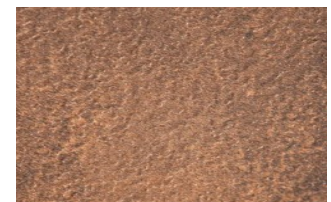

FB-CT3  
West Corten Sense



FB-H45  
Fresh Concrete Sense



FB-H01  
Drv Concrete



FB-H02  
Slate Concrete



FB-P12  
Tromso Winter



FB-H03  
Concrete Basalt



FB-P01  
Symphony Urban



FB-P04  
Namibia Ambar

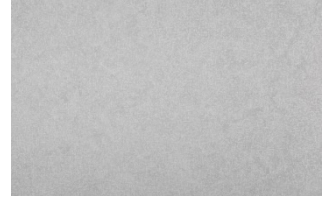

FB-V01  
Valante Grey



FB-V03  
Valante Blue

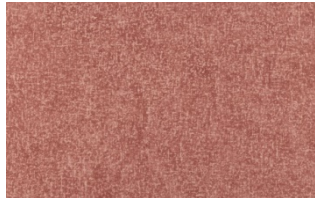

FB-V03  
Valante Red

### Acabamentos Mineral

### Mineral Finishes

### Finitions Mineral

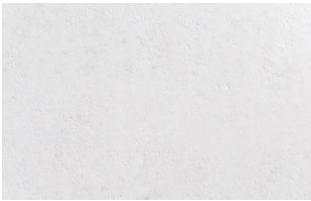

FB-R01  
Fira Sense



FB-R03  
Megara Sense



FB-R04  
Turia Sense



FB-R02  
Tebas Sense

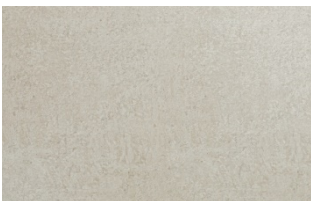

FB-ST3  
Corbel Sense



FB-PC1  
Palatino Sense



FB-TR2  
Matte Travertine



FB-GR3  
Gallaecia Sense

# Sistema de fixação

## Fixation system

## Systeme de fixation



O sistema de fixação **FIXIN®** para cassetes em fachadas ventiladas é uma inovação que possibilita a aplicação do painel **FIXBOND®** no revestimento de fachadas novas ou na reabilitação de edifícios antigos.

Com este sistema passamos a disponibilizar a todos os instaladores de painel compósito de alumínio facilidade, versatilidade e velocidade na sua instalação.

Esta união de materiais dota o painel compósito de excelentes propriedades mecânicas: alta resistência aos choques, elevada rigidez e reduzido peso.

The **FIXIN®** fixing system for cassettes in ventilated facades is an innovation that allows the application of the **FIXBOND®** panel, in coating new facades or in the rehabilitation of old buildings.

With this system we make available to all aluminum composite panel installers ease, versatility and speed in their installation.

This joining of materials endows the composite panel with excellent mechanical properties: high shock resistance, high rigidity and low weight.

Le système de fixation **FIXIN®** pour les cassetes en façades ventilées est une innovation que permet l'application du panneau **FIXBOND®** dans le revêtement de nouvelles façades ou la réhabilitation des vieux bâtiments.

Avec ce système, nous avons mis à la disposition de tous les installateurs de panneau composite en aluminium, facilité, versatilité et vitesse dans leur installation.

Cette union de matériaux dote le panneau composite d'excellentes propriétés mécaniques, haute résistance au choc, rigidité élevée et un poids réduit.

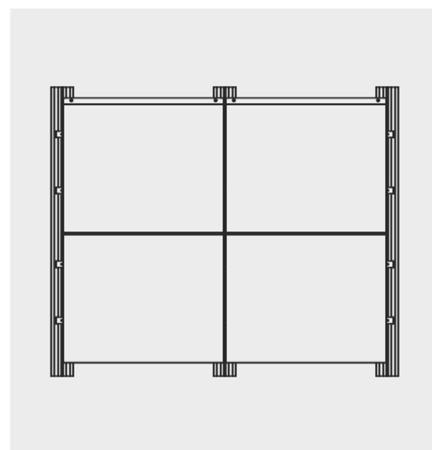
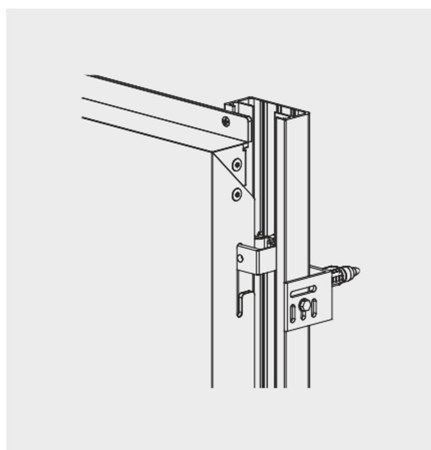
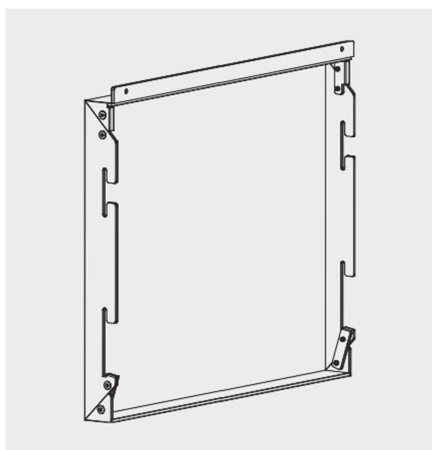

BY MERCANTLIS  
**FIXbond**<sup>®</sup>  
ALUMINIUM COMPOSITE PANEL

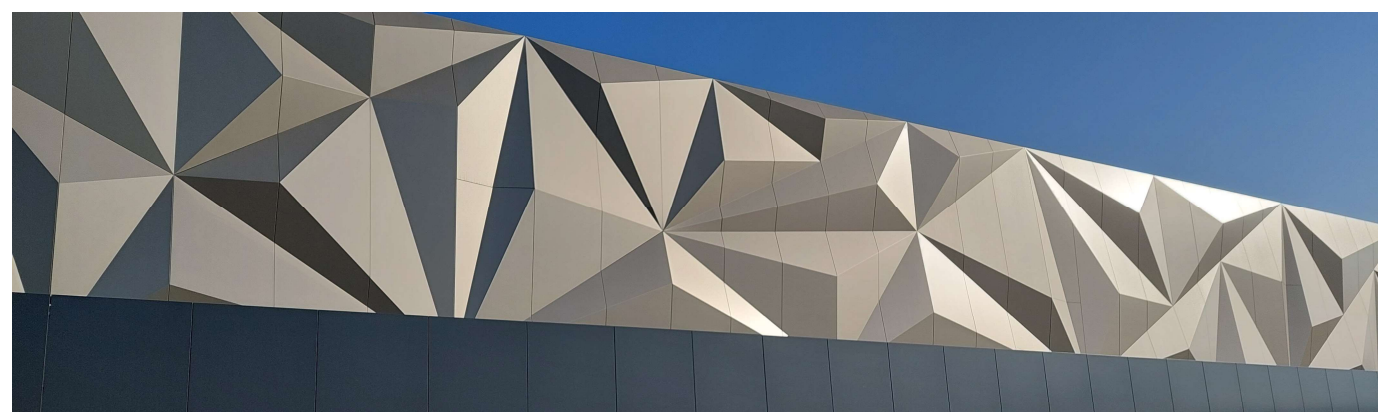

Estrada Nacional 109, n°1295 | 2415-199 Regueira de Pontes | Leiria | Portugal  
Telef.: +351 244 833 698 | Tlm.: +351 919 922 263 | geral@mercantlis.com

[www.fixbond.pt](http://www.fixbond.pt)